



EUROPEAN PATENT APPLICATION

 Application number: 85301844.8

 Int. Cl.: G 01 N 33/543

// G01N33/76, B01L3/00

 Date of filing: 15.03.85

 Priority: 15.03.84 GB 8406752

 Applicant: UNILEVER PLC, Unilever House Blackfriars
 P.O. Box 68, London EC4P 4BQ (GB)

 Designated Contracting States: GB

 Date of publication of application: 11.12.85
 Bulletin 85/50

 Applicant: UNILEVER NV, Burgemeester
 s'Jacobplein 1 P.O. Box 760, NL-3000 DK Rotterdam (NL)

 Designated Contracting States: BE CH DE FR IT LI NL
 SE AT

 Inventor: Blake, Anthony, 8 Armstrong Close, West Perry
 Huntington (GB)

Inventor: Coley, John, 10 Carrisbrooke Close, Kettering
 Northamptonshire (GB)

Inventor: Smith, Ronald, 48 Sylmonds Gardens, Rushden
 Northamptonshire (GB)

 Designated Contracting States: AT BE CH DE FR GB IT
 LI NL SE

 Representative: Stancliffe, Terence Christopher et al,
 UNILEVER PLC Patents Division P.O. Box 68 Unilever
 House, London EC4P 4BQ (GB)

 Devices for carrying out chemical and clinical tests, and their use.

 A device for carrying out chemical or clinical testing of a liquid sample, for example a urine sample, by a specific binding assay, said device comprising a test component (2) which has a sensitised solid surface (2a) carrying an immobilised component of a specific binding pair relevant to the assay, and a handling piece (1), and characterised in that the test component (2) bearing the sensitised surface (2a) is removably mounted in spaced relationship with a removably mounted accessory component (4) carrying an accessory solid surface (5), and in that there is a space (4a) between the sensitised surface (2a) and the removable accessory component (4) to act as a container for sample liquid, so that when the device is contacted with a sample liquid source or immersed in liquid which is to provide the test sample, liquid of the sample can enter the space (4a) to contact the sensitised surface (2a), and the accessory surface (5) acts to retain and contain sample liquid in contact with the sensitised surface (2a) even after removal of the device from further contact with or immersion in the source of sample liquid, and in that the test component (2) is so formed that after removal of the removable accessory component (4) the sensitised surface (2a) is left exposed and accessible to further treatment liquid such as washing liquid and/or reagents.

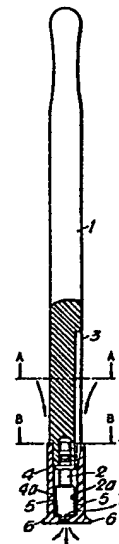

EP 0 164 180 A1

DEVICES FOR CARRYING OUT CHEMICAL AND
CLINICAL TESTS, AND THEIR USE

5 This invention relates to devices for chemical and
clinical testing, and their use. It particularly
concerns improved apparatus for carrying out such tests.
The devices of the invention are applicable to a
well-known range of tests, which range is wide and not
particularly limited by the function or chemical basis of
10 the tests: it especially includes the known specific
binding or specific affinity tests, for example
immunologically-based methods of detection such as
immunoassays: (all such immunological and other specific
binding methods are generically referred to in this
15 specification as immunoassays). The literature of
specific binding assays reviewed in European Specification
No 0 014 530 is representative of known kinds of such
assays.

20 A large range of apparatus types has been devised to
carry out immunoassays and other clinical tests: in nearly
every case the test procedure demands the interaction of
plural reactants and a corresponding large number of
manipulations is required on the part of the user. The

range of apparatus already known includes tubes, beads, slides, and tube inserts coated with sensitising material for the purposes of the tests, and proposals have also been made to use sensitised brushes or bodies with a convoluted surface to carry sensitising material, e.g. immunosorbent material, such as for example antibody, antigen or specific binding partners for either of them.

It is an aim of this invention to simplify the handling of such tests. It is also an aim of this invention to provide apparatus for clinical immunological testing which is simple and convenient to use in an environment far removed from a specialist immunological testing laboratory, e.g. at a patient's bedside or at home.

A further aim of the invention lies in providing a construction of apparatus for simplified clinical and chemical testing involving a sensitised carrier body which facilitates uniform production of such a sensitised body as well as its convenient handling in use.

According to the invention, an apparatus for carrying out a test or assay of any of the kinds described above, using a liquid sample possibly containing some quantity of an analyte to be tested for, includes a sensitised solid surface and is improved in the following way: the test component which includes the sensitised solid surface is removably mounted in spaced relationship with an accessory solid surface carried on an accessory body, so that upon contact with or immersion in liquid which is to provide the test sample, liquid of the sample contacts the sensitised solid surface, and the accessory solid surface acts to retain sample liquid (in some embodiments, possibly a definite, consistent, and maybe standardised volume of sample liquid) in contact with the sensitised

solid surface after any removal of the apparatus from further contact with or immersion in the liquid. In certain embodiments, the accessory solid surface can be closely spaced from the sensitised surface, and may be so placed that it helps in conducting a flow of sample liquid over the sensitised solid surface, e.g. by capillary action or other effect of surface tension. In other embodiments, the accessory solid surface can take the form of a sample liquid holder such as a cup, which is removably fitted to the test component or to the handle. In use, the test component is later removed from its association with the accessory solid surface, and can be treated further, e.g. by washing and exposure to further reactant.

15

The description given hereinbelow gives forms and examples of the improved devices according to the invention, for carrying out chemical or clinical testing of liquid samples, for example urine samples, by specific binding assay, such a device comprising a test component (2) which has a sensitised solid surface (2a) carrying an immobilised component of a specific binding pair relevant to the assay, and a handling piece (1), and in which the improvement comprises a removably mounted accessory component (4) carrying an accessory solid surface (5), which is removably mounted in spaced relationship with the test component (2) bearing the sensitised surface (2a), whereby there is left a space (4a) between the sensitised surface and the removable accessory component (4) to act as a container for sample liquid, so that when the device is contacted with a sample liquid source or immersed in liquid which is to provide the test sample, liquid of the sample can enter the space (4a) to contact the sensitised surface (2a), and the accessory surface (5) acts to retain and contain sample liquid in contact with the sensitised surface (2a) even after removal of the device from further

20

25

30

35

contact with or immersion in the source of sample liquid, the test component (2) being so formed that after removal of the removable accessory component (4) the sensitised surface (2a) is left exposed and accessible to further treatment liquid such as washing liquid and/or reagents. The numerals given in the above statement are intended only for purposes of illustration and explanation but not of limitation, and refer to particular examples of the device as given below and illustrated in the accompanying drawings.

A prior art search based on the subject matter of the present invention has disclosed the existence of the following references:

GB 2 012 955 (Abbott) describes for example an immunotest device comprising an open tube with an immunosensitised bead trapped within, intended to allow decantation of liquid without losing the bead.

GB 1 537 537 (American Home Products) describes for example a testing device for detecting or measuring HCG in serum or urine: the device calls for sample liquid to be added to a device comprising a receptacle and an insert: the insert comprises an arrangement of semipermeable membrane and absorbent and is intended to reduce the bulk of the sample liquid by ultrafiltration, while leaving the analyte outside the membrane in concentrated form, to react later with an agglutination/inhibition reagent in the base of the receptacle after removal of the insert.

GB 1 511 607 (ICL/Scientific) describes for example a urine test device comprising a tube and an aspirator that fits within the tube, intended to suck up the lower part of a liquid sample contained in the tube, possibly

together with any particles in the liquid sample that may have sedimented to the bottom of the tube.

5 GB 2 015 158 (Reijo Vihko) shows for example
discardable immunotest apparatus with a series of
detachable connected parts, each carrying antibodies on
its surface for reaction with each of several antigens.
The detachable parts can be interlocking tubes, and there
is mention by way of alternative of parts disposed one
10 within another and facing one another to define a reaction
space between them.

GB 1 584 129 (Piasio et al) shows for example an
immunotest arrangement with a receptacle and an
15 immunologically sensitised solid insert with a handle and
a plurality of elements, eg fins, attached to the handle.

GB 1 571 782 (Finn-Pipette Osmo) shows for example
annular solid immunologically sensitised inserts for
20 immunotest reaction vessels, to allow measurement light
for photometry of the reaction solution to pass through
the holes in the annuli.

GB 1 414 479 (Abbott) shows for example
25 immunologically sensitised solids provided with handles
and made in the shapes of inter alia hemispherical,
conical and cruciform inserts for immunotest reaction
containers, together with reaction containers of
complementary shape, eg hemispherical or conical.

30 EP 0 042 755 (Unilever) shows for example interfitted
sticks or rods with immunosorbent surfaces carried in
multiple on handling-pieces and for insertion into
immunotest reaction vessels.

35

5 EP 0 031 993 (Ventrex) shows for example an immunotest apparatus with a sensitised "fin-stick" (a rod carrier to which a number of immunologically sensitised vanes is attached) retained within an immunotest reaction tube.

10 EP 0 014 797 (Eastman Kodak) shows for example a liquid-spreading device with opposed plates bearing crossed microgrooves.

15 EP 0 010 456 (Eastman Kodak) shows for example a liquid transport device with an aperture to a receptacle having interior corners, eg a hexagonal inlet aperture.

20 Also in the prior art are microdiluters for laboratory use, comprising handles with multi-prong ends to pick up desired volumes of liquid and hold them mostly by capillary action before they are transferred and dispensed into larger liquid volumes.

25 Also in the prior art are numerous liquid sample collection and testing devices including urine collection and testing devices, based on cups or tubes or dropper tubes or reagent strips to be wetted with the sample liquids.

30 Several of the prior art arrangements above, though intended for immunotests, have not been designed with a view to easy handling of body fluid samples such as urine samples.

35 Considered from the point of view of those users of such tests who may not be skilled in the art of handling and measuring liquid volumes as in a laboratory, we believe the arrangements of the prior art, including those intended for application to body fluid collection and

testing, are generally somewhat messy and awkward to use, or at least to use with a degree of accuracy needed for satisfactory execution of the tests to be performed with their aid.

5

It is an aim of the invention to provide greater convenience of handling in connection with such liquid collection and diagnostic test procedures.

10

Particular embodiments of the devices of the invention are given by way of example without limitation as follows:-

(a) The test component carrying the sensitised solid surface can be a slip, plate, bead, peg or section of hollow body such as tubing, mounted on a handle or other holder.

(b) The accessory solid surface can be of substantially complementary shape to the sensitised solid surface and be removably fixed at a location close to but spaced slightly apart from the sensitised surface; it can be a surface of e.g. a shroud, mesh, cover or plug.

(c) The accessory body can be for example a removable snap-on/snap-off fitment or a frictional sliding fitment on the handle or holder, or on the test component carrying the sensitised solid surface. If desired, the handle or holder can have an ejection device which the user can manipulate to dislodge or demount the accessory body when desired.

In one form of device according to the invention, the accessory body can comprise a body of absorbent liquid-retentive material such as a sponge, to hold sample

35

liquid in contact with the sensitised surface of the test component.

5 When the test component carrying the sensitised solid surface is fitted to the accessory body carrying the accessory solid surface, they cooperate in such a way that passage is left for entry of sample liquid into the space between the sensitised surface and the accessory surface. Passages can be formed according to convenience either
10 within the handle, within the accessory body carrying the accessory surface, or within the test component, or at the places where any two of these three contact each other. The location of such passage can be chosen at will according to the particular shapes chosen for the rest of
15 the apparatus.

 Preferably there is also another passageway provided for air to escape from the surfaces between which the sample liquid is to enter, but the need for this depends
20 on the overall form of the apparatus and passage for liquid entry.

(d) The test component can be removed from its mounting in association with the accessory body, with its
25 accessory solid surface, by pulling off the snap-off or frictional sliding fitment. This can most conveniently be done if the accessory body possesses (in addition to its means for removable connexion to the test component carrying the sensitised solid surface) means for
30 attachment to a test kit base or other component which can be handled easily and used to detach the accessory body from its fitted position in proximity to the test component.

35 It can be especially convenient and desirable to provide the test component carrying the sensitised solid

surface as a plug-in fitment to a handle: the test component may be either detachable from the handle or not. Then the test component can be mass-produced to ensure uniformity, without involvement of the handle piece in the
5 manufacturing conditions.

In one type of embodiment of the invention which can centre around a sensitised component plug-fitted to a handling-piece, the accessory surface can be that of a
10 sample holder which functions as a cup to hold sample liquid around the sensitised surface of the test component.

The sample holder can have formations (e.g. vanes)
15 allowing it to be push-fitted on to the sensitised component and/or handle. The holder can also be arranged for positive location on a stand or in a further container or handling piece. Then the steps needed to use the device are (a) fill the holder with sample liquid enough
20 to contact the sensitised surface, (b) leave in contact long enough for the needs of the particular test in view, (c) engage the holder with the stand or further container or handling piece, (or otherwise eject or dispose of the sample-liquid holder and its contents), so as (d) to
25 obtain the handle and test component free of the other parts of the apparatus so far used, and (e) then to subject the test component to any further procedures needed by the particular test in view.

30 It will often be convenient to incorporate the stand or further container or handling piece (or other means to separate the test component from the component carrying the accessory solid surface) as part of the packaging or casing in which the test apparatus is supplied to the
35 user, e.g. as part of the lid or base of such a casing.

Where the test to be carried out requires accessory reagents, some or all of these can if desired be deposited on the surface of the accessory body in proximity to the sensitised surface of the test component. For example, an immunoassay apparatus according to the invention may call for an immunosorbent sensitisation of the test component surface: and in the event that a labelled immunological material is also involved in the test reaction, such a material (e.g. an enzyme-labelled antigen, hapten or antibody) can be carried on the accessory solid surface, e.g. in a form which is releasable into the sample liquid layer held between the test component and the accessory solid surface, such as a dry layer, e.g. a sucrose glaze, or a thin film layer based on gelatin or other film-former such as polyvinyl alcohol. The formation of such layers and glazes is well known in itself and in itself does not constitute this invention. In this case, it will usually be desirable and even necessary for the volume of sample liquid retained between the accessory surface and sensitised test component surface to be consistent and standardised, as can be achieved by the use of examples as illustrated below.

Most usually, the sensitised surface of the test component of the apparatus described herein is sensitised by immobilising an antibody or antigen or other component of a specific binding reaction to the surface, in known manner. Such immobilisation methods are now well known and widespread in the literature and in themselves do not constitute the present invention. One preferred method is to adsorb the antibody to a polystyrene surface in known manner. Other suitable methods are described and cited in European Specification No 0 014 530, especially the glutaraldehyde method and the methods described in USP 3 817 837 (cols 31-34), and GB Specifications Nos 1 316 990 and 1 485 122-3.

Suitable examples of glutaraldehyde coupling techniques have been available in the literature for a long time, in for example S Avrameas, (1969) Immunochem 6 pp 43 et seq, and in "The Enzyme Linked Immunosorbent Assay (ELISA)" by A Voller, D F Bidwell and A Bartlett, (1979) (published by Dynatech Europe, Guernsey, ISBN 0.906036.01.1).

Since at present the most wanted application of the devices of the present appears to be for the purpose of pregnancy testing by analysis of female (especially, but not exclusively, human) urine samples, a corresponding suitable material to fix on to the test component surface is antibody to human chorionic gonadotrophin (HCG). Other antibodies which are suitable coupling partners for the purposes of tests of related diagnostic significance are for example anti-luteinising hormone (anti-LH) and anti-prolactin. Antigens and haptens are further suitable examples of coupling partners, especially HCG itself.

The chemical reaction schemes of the assays which are carried out by the help of the devices of the present invention do not in themselves constitute or limit this invention. It can be mentioned, however, that any of the known specific binding assay reaction formats, such as a competitive assay, sandwich assay, immunometric assay, or antiglobulin assay, among others, can be carried out by suitable choice and arrangement of known reagents in known manner. Representative literature about the occurrence of urinary analytes related to pregnancy and fertility is given in for example USP 4 016 250 and 4 094 963. The use of the devices of the present invention is not however limited to any one example of an immunoassay or diagnostic assay.

Example and Drawings

5 The following description gives examples of apparatus of the invention and explains its use by reference to test reagents and preparative conditions which are substantially conventional and of well-known kind, chosen for illustration, which in themselves do not constitute the present invention.

10 Figures 1, 2A and 2B of the accompanying drawings show a diagrammatic part-section through an embodiment of apparatus in accordance with the invention, together with auxilliary cross-sections through lines A-A and B-B in the main section.

15 Figure 3 shows in diagrammatic part cross-section a base unit for use with the device of Figures 1, 2A and 2B.

20 Figures 4-6 show in diagrammatic plan cross-section and elevation a further form of the apparatus.

Shown in the diagrammatic part-sectional drawings is an apparatus for carrying out immunological tests comprising a handle 1 of plastics material. Into a recess
25 in the lower end of handle 1 is plugged in a polystyrene or nylon peg 2 which has been sensitised in known manner with a high-affinity anti-HCG antibody, reacted with the plastics surface in sensitising treatment liquid under sensitising conditions (eg those appropriate to a known
30 adsorption or glutaraldehyde method) at a concentration of about 2 micrograms/millilitre. The part of the peg 2 having a sensitised surface 2a is of the order of 5 millimetre long in a suitable embodiment of this example. Techniques for preparation of immunosorbents are well
35 known in themselves and need be no further described to enable the skilled reader to carry out this invention.

Handle 1 also has a number of longitudinal grooves 3 therein, to allow passage of sample liquid towards the sensitised part of peg 2. As a frictional sliding fit over the end of handle 1 and over peg 2 there is provided
5 a perforated plastics shroud 4 of which the internal surfaces 5 are substantially complementary in shape to the overall shape of sensitised surfaces of the peg 2. Shroud 4 also in this embodiment has grooves 3a complementary to
10 grooves 3 to allow passage of sample fluid into the centre space within shroud 4. There is no need however for any grooves or the like which may be present on the sensitised part of the peg 2 to be repeated in the surface 5. The space 4a within shroud 4 between surface 5 and surface 2a
15 of peg 2 may be such as to allow of the order of 50 microlitre of liquid, (e.g. up to 100 microlitre) to be held between them. Using these dimensions, this can easily be arranged to be a defined or standard volume of liquid taken up automatically and regulated by surface
20 tension/capillarity when the device is used.

Shroud 4 also carries flanges 6 which allow it to be positively located and locked in place on a holder base (8). Shroud 4 also has a lower perforation 7 to allow
25 escape of air when the assembly of handle 1, peg 2 and shroud 4 is exposed to sample liquid, and sample liquid enters via grooves 3 and 3a to contact peg 2 and surfaces
5. Holder base 8 has flange formations 9 which together with the rest of base 8 form a groove or grooves by which to interlock with and hold shroud 4 as a sliding fit by
30 its flanges 6. Base 8 also has two or more reagent wells 10 and 11 fitted with removable seals to contain reagents to carry out the test.

In use, the assembly comprising handle 1, peg 2 and
35 shroud 4 is exposed to and contacted with a source of liquid to provide a sample. This may be a sample of

serum, or urine, e.g. the lower end of the assembly may be held in a urine stream of a person to be the subject of the test, to collect a sample, which enters into space 4a between the sensitised surface 2a and accessory component 4.

After sample collection, the assembly may be removed from the source and slotted into flanges 9 by means of flanges 6 so that it is held in holder base 8, and allowed to stand to incubate for a specified time chosen to suit the particular reagents involved, so that the sample liquid reacts with the specific binding agent carried by surface 2a. Then the user may pull handle 1 and peg 2 away from the holder, separating test component 2 from accessory component 4, leaving shroud 4 behind. The user can then wash the peg 2 in water or other wash fluid if so instructed according to the nature of the particular test, which in itself does not constitute this invention, and dip the peg successively for specified times (which may be for example of the order of 5-30 minutes per reaction step) with intermediate washes, into reagent wells 10 and/or 11 successively. In the present example, when applied to a test for HCG, the well 10 may be provided with a liquid having a content of HCG conjugated with alkaline phosphatase, (e.g. at 0.2 microgram/millilitre) and a tear-off sealing foil cover, and well 11 may be provided with a liquid having a content of (e.g. 1 mg/ml) bromochloroindolyl-phosphate (substrate reactable with alkaline phosphatase to yield blue product, under known suitable conditions). According to the content of HCG in the original sample, the liquid in well 11 either develops or fails to develop a blue coloration after incubation. This can be visualised by a colour comparison chart, if desired in the presence of a (possibly inert) background colour (e.g. yellow) to convert the colour development

into a change of hue, e.g. from yellow to green. The reagents mentioned hereinabove are all well known per se.

5 In an alternative embodiment the conjugate with alkaline phosphatase (or other enzyme, such as peroxidase) can be supplied instead as a releasable dried layer on surface 5 of accessory component 4, as mentioned above.

10 By suitable choice of known colour-forming reaction, in alternative embodiments, the colour can be made to develop in liquid form or on the sensitised surface itself. Any suitable known enzyme or colour-developing reaction can be used in connection iwth the tests which are carried out by the aid of the devices of the present
15 invention.

The invention described herein comprises any and all combinations of the features and steps set out above, and the skilled reader will appreciate that the invention
20 includes a wide variety of modifications based upon such disclosure.

A further and preferred variant embodiment of the invention is illustrated with reference to further
25 accompanying drawing Figures 4, 5 and 6.

30 These figures respectively show a diagrammatic and part-sectional plan, cross-section on line AA in the plan, and side elevation towards AA, of a sampling and testing apparatus according to this further embodiment.

In these drawings, similar numbers to the numbers shown in Figures 1-3 indicate functionally similar parts comparable with the parts indicated in the earlier
35 drawings.

In this embodiment, referring to shroud 4 shown in section in Figure 5, a downwardly extending rim 7a is provided so that when the sampling handle and shroud are placed vertically on a flat surface, the surface does not interact with any liquid meniscus located in passageway 7 after a liquid sample has been collected. Passageway 7 is in this embodiment less than about 0.5-0.6mm, e.g. about 0.3mm in diameter, and the peg 2 and shroud 4 are dimensional substantially as described in connexion with the earlier drawings.

The base-unit of this further embodiment shows a modified layout (Figure 4), and in particular a double-socket compartment 9a into which the shroud 4 can be plugged, and moved to one side (left as seen in the drawing), to enable the handle and peg to be pulled free when flanges 9 have engaged with the complementary rim 6 on shroud 4.

It will be understood that any of the features of this further embodiment can be modified and combined with the foregoing description.

Claims

1. A device for carrying out chemical or clinical testing of a liquid sample, for example a urine sample, by
- 5 a specific binding assay, said device comprising a test component (2) which has a sensitised solid surface (2a) carrying an immobilised component of a specific binding pair relevant to the assay, and a handling piece (1), and characterised in that the test component (2) bearing the
- 10 sensitised surface (2a) is removably mounted in spaced relationship with a removably mounted accessory component (4) carrying an accessory solid surface (5), and in that there is a space (4a) between the sensitised surface (2a) and the removable accessory component (4) to act as a
- 15 container for sample liquid, so that when the device is contacted with a sample liquid source or immersed in liquid which is to provide the test sample, liquid of the sample can enter the space (4a) to contact the sensitised surface (2a), and the accessory surface (5) acts to retain
- 20 and contain sample liquid in contact with the sensitised surface (2a) even after removal of the device from further contact with or immersion in the source of sample liquid, and in that the test component (2) is so formed that after removal of the removable accessory component (4) the
- 25 sensitised surface (2a) is left exposed and accessible to further treatment liquid such as washing liquid and/or reagents.

2. A device according to claim 1, further characterised by a support component (8), for example in the form of a base unit, and wherein the removable accessory component (4) which is removably mounted to the test component (2),
5 and the support component (8), are so formed with interlocking means (6,9) such as a flange and groove that they can be interlocked to enable a user of the device to remove the accessory component (4) from the test component without handling either the test component (2) or the test
10 component (4) directly.
3. A device according to claim 1 or 2, characterised in that a support component (8) such as a base unit is provided which also comprises one or more liquid reaction
15 wells (10,11) for containing reagents for the assay.
4. Apparatus according to claim 1, 2 or 3, characterised in that the accessory surface (5) is a surface of a perforated or apertured removable shroud or cover (4)
20 arranged around the sensitised surface (2a) and closely spaced a short distance (4a) from the sensitised surface (2a), and removably fitted to the test component (2) or to its handle (1).
- 25 5. Apparatus according to claim 1, characterised in that the accessory surface (5) of removable component (4) provides a sample liquid holder such as a cup which is removably fitted to the test component (2) or to its handle (1).

6. A device according to any preceding claim,
characterised in that the removably fitted accessory
component (4) is a removable frictional fit on the test
component (2) or its handle (1), and one or more apertures
5 (3) for penetration of sample liquid into the container
are left between the test component (2) and the accessory
component (4).
7. A device according to any preceding claim,
10 characterised in that the space (4a) between the
sensitised solid surface (2a) and the removably fitted
accessory component (4) is narrow enough to retain sample
liquid by capillarity or surface tension.
- 15 8. A device according to any preceding claim,
characterised in that the space (4a) between the
sensitised solid surface (2a) and the removably fitted
accessory component (4) define a constant or standard
sample liquid volume.
- 20 9. A device according to any preceding claim,
characterised in that an aperture (7) is provided in
removable accessory component (4) to allow escape of air
from the space (4a) when the device is used to collect a
25 sample.
10. A device according to any preceding claim,
characterised in that the surface (5) of the removable
accessory component (4) carries a releasable reagent (such
30 as a dried layer of antibody conjugate) which is able to
disperse in the sample liquid when the device is used.

11. A device according to any preceding claim,
characterised in that the sensitised surface (2a) of the
test component (2) bears a (known per se) component
(analogue or binding partner) of a specific binding
5 reaction pair involving human chorionic gonadotrophin
(HCG) (for example an antibody specific for HCG)
immobilised thereon, and in that remaining reagents (known
per se) for enzyme-linked immunoassay of HCG, including an
enzyme-conjugated component (analogue or binding partner)
10 of a specific binding reaction pair involving HCG, (for
example an enzyme-conjugated antibody to HCG, or an
enzyme-conjugated HCG), are provided in or on either the
surface (5) of accessory component (4), and/or in
associated reaction wells (10,11) of a base support unit
15 (8).
12. A device according to any preceding claim,
characterised by the joint and several features of the
accompanying specification, examples and drawings.
20
13. Use of the devices according to any preceding claim
for immunoassay of urinary components.

14. A process for sampling urine and carrying out a clinical/chemical test by a specific binding assay, by the use of a device according to any of claims 1-12, characterised by contacting the device with a source of the urine to be sampled (such as a urine stream of a person subject of the test), so that a sample quantity of liquid enters space (4a) between the sensitised surface (2a) and the removable accessory component (4), then removing the device from the source of sample liquid and allowing the sample liquid to react with the specific binding agent carried by surface (2a), then separating the accessory component (4) from test component (2) to expose the sensitised surface (2a) to further washing and/or reagent treatment.

15

1/2

Fig.1.

Fig.2A.

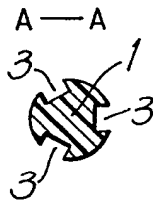

Fig.2B.

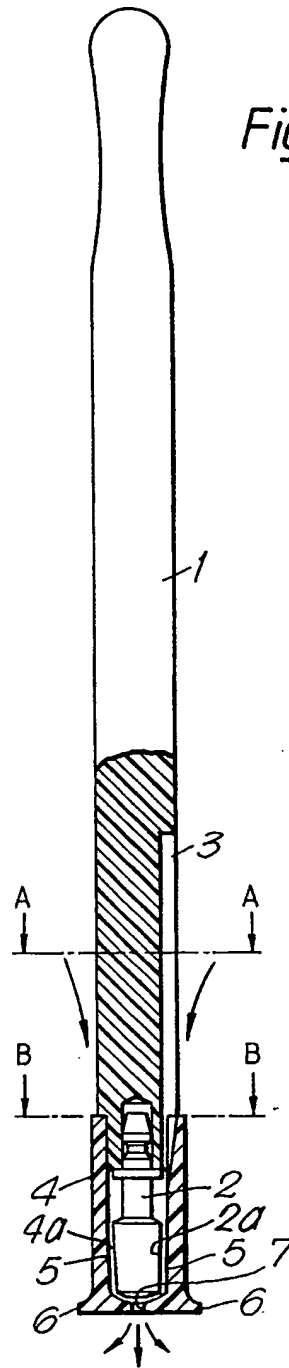
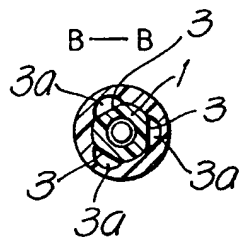
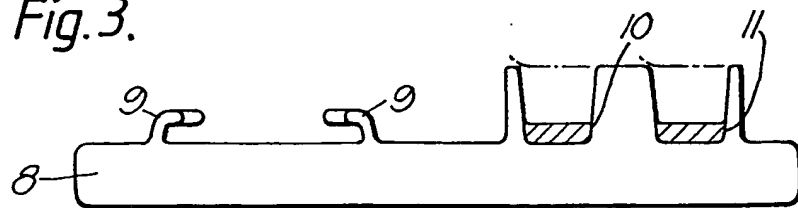

Fig.3.



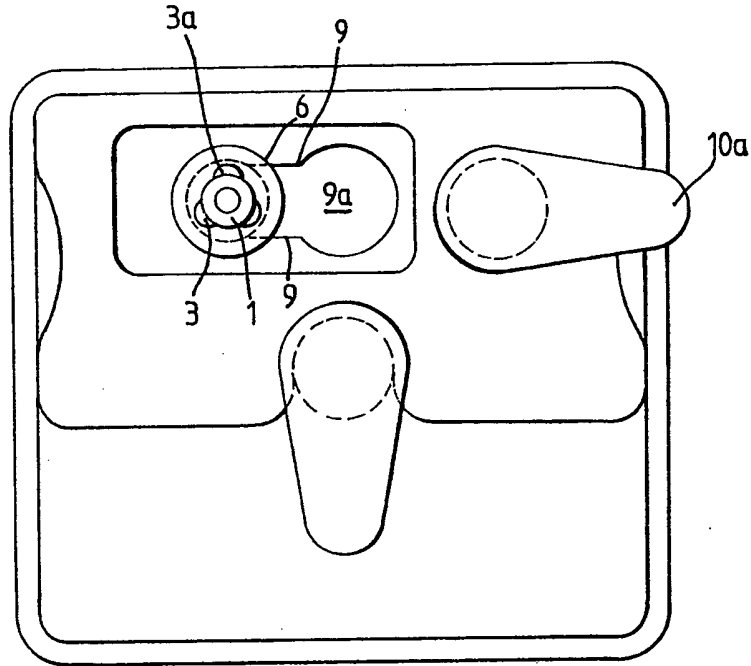

Fig. 4.

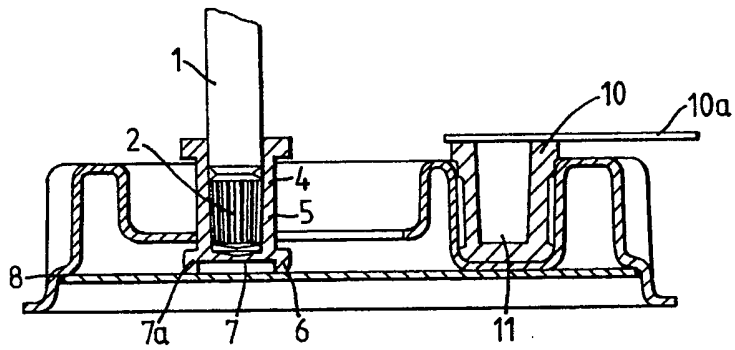

Fig. 5.

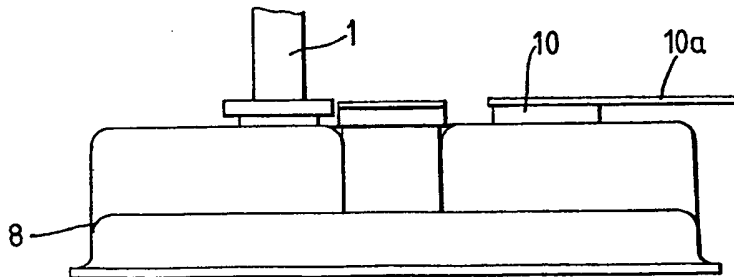

Fig. 6.



European Patent
Office

EUROPEAN SEARCH REPORT

0164180

Application number

EP 85 30 1844

DOCUMENTS CONSIDERED TO BE RELEVANT			
Category	Citation of document with indication, where appropriate, of relevant passages	Relevant to claim	CLASSIFICATION OF THE APPLICATION (Int. Cl.4)
A	US-A-3 826 619 (N.G. BRATU et al.) * column 1, line 62 - column 2, line 65 * & GB - A - 1 414 479 (Cat. D)	1, 11	G 01 N 33/543// G 01 N 33/76 B 01 L 3/00
D, A	GB-A-2 015 158 (REIJO VIHKO) * page 1, line 99 - page 2, line 38 *	1, 11	
A	US-A-4 135 884 (J.T. SHEN) * column 1, line 26 - column 2, line 55 *	1, 11, 13	
A	FR-A-2 498 331 (KADOUCHE)		
A	WO-A-8 202 211 (COMMONWEALTH SERUM LABORATOIRES COMMISSION)		
			TECHNICAL FIELDS SEARCHED (Int. Cl.4)
			G 01 N 33/00 C 12 Q 1/00 B 01 L 3/00
The present search report has been drawn up for all claims			
Place of search BERLIN		Date of completion of the search 19-07-1985	Examiner GREEN C.H.
<p>CATEGORY OF CITED DOCUMENTS</p> <p>X : particularly relevant if taken alone Y : particularly relevant if combined with another document of the same category A : technological background O : non-written disclosure P : intermediate document</p> <p>T : theory or principle underlying the invention E : earlier patent document, but published on, or after the filing date D : document cited in the application L : document cited for other reasons & : member of the same patent family, corresponding document</p>			

PO Form 1503 (03.82)

THIS PAGE BLANK (USPTO)